

Collection Day

Modulo / Logico

D

ORME

Orme – Collezione Giorno

Nate dall'esperienza e dalla ricerca di Orme, firma del Gruppo Homes, le collezioni Modulo e Logico di Orme interpretano con sapienza, creatività e sartorialità uno stile d'arredo e di vita, in armonia fra classico e contemporaneo. Un progetto che si evolve, dedicando nuove collezioni ed attenzioni al cuore di ogni casa: l'ambiente living. Nuova la gamma delle finiture materiche che valorizzano lo spazio, con la raffinata artigianalità e il calore naturale delle superfici impiallacciate, oppure con un'armoniosa quanto seducente scelta di tonalità laccate. Nuovi gli elementi in metallo o legno che contribuiscono a rendere ogni situazione d'arredo più originale e versatile. Nuova l'estetica delle maniglie, dettagli protagonisti dello spazio. Ancora più ampie e aggiornate la modularità e le possibilità compositive, per inserirsi in ogni ambiente e offrire una totale libertà di progettazione.

Collection Day – Based on the experience and research carried out by Orme, Homes Group brand, the Orme Modulo and Logico collections are skilful, creative and sartorial interpretations of a style of furniture and a style of living, balancing the classic and the contemporary. A project in progress, bringing new collections and new focus to the heart of every home, the living area. With a new range of material finishes which enhance the space with sophisticated craftsmanship and the natural warmth of veneered surfaces, or with a coordinated and equally attractive choice of lacquer finish colours. With new elements in metal or wood which go to make every furnishing situation more original and versatile. With a new aesthetic for the handles, key details in the space. An even more extensive and updated modular range and potential for composition, for installation in every area and for total design freedom.

Day 01 Modulo
pagina 04 › 13

Day 02 Modulo
pagina 14 › 19

Day 03 Modulo
pagina 20 › 27

Day 04 Modulo
pagina 28 › 35

Day 05 Modulo
pagina 36 › 43

Day 06 Modulo
pagina 44 › 49

Day 07 Modulo
pagina 50 › 55

Day 08 Modulo
pagina 58 › 63

Day 09 Modulo
pagina 64 › 71

Day 10 Modulo
pagina 72 › 77

Day 11 Modulo
pagina 78 › 85

Day 12 Modulo
pagina 86 › 95

Day 13 Modulo
pagina 96 › 103

Day 14 Modulo
pagina 104 › 111

Day 15 Modulo
pagina 114 › 123

Day 16 Modulo
pagina 124 › 131

Day 17 Modulo
pagina 132 › 139

Day 18 Modulo
pagina 140 › 147

Day 19 Modulo
pagina 148 › 153

Capitolo N°1

Collection Day – Modulo



Day 01

IT – Un'apparente semplicità che nasce da un profondo studio delle proporzioni e degli abbinamenti fra colori e materiali. Pochi volumi sospesi bastano a definire uno spazio giorno da vivere con un innato senso della bellezza e dell'armonia. Riflessi preziosi amplificano lo spazio e creano affascinanti prospettive.

EN – Apparent simplicity which comes from in-depth study of the proportions and combinations of colours and materials. A few wall-mounted volumes are enough to define an area for living with an innate sense of beauty and harmony. Exquisite reflections amplify the space and create interesting perspectives.

Finiture/Finishes

Laccato opaco Cannella, Frassino
Carbone, vetro Bronzato/Cannella matte lacquer
finish, Carbone Ash, Bronzato glass

Elementi/Elements

Consolle sospesa P 420 mm con elementi
Strema a giorno e con cassetti in cuoio,
pensili con anta Glass vetro Bronzato
/Wall-mounted console D 420 mm, with
open Strema modules and drawers in leather,
wall units with Bronzato Glass door

Dimensioni/Dimensions

L 3900 × H 1650 P 420 – 350 mm





Dettaglio consolle sospesa con elementi Strema in Frassino Carbone, pensili con anta Glass vetro Bronzato
/Detail of wall-mounted console with Strema modules in Carbone Ash, wall units with Bronzato Glass door



Dettaglio tavolo Slim L 1600 x 900 mm con struttura laccata opaca Cannella e piano in Frassino Carbone
/Detail of Slim table, width 1600 x 900 mm with Cannella matte lacquer finish structure and top in Carbone Ash

Finiture/Finishes

Laccato opaco Cannella, laccato opaco Tufo/Cannella matte lacquer finish, Tufo matte lacquer finish

Elementi/Elements

Madia Virgo con basamento Tiglio verniciato Brunito/Virgo sideboard with Brunito coated Tiglio base

Dimensioni/Dimensions

L 1200 x H 1592 P 420 mm



Day 02

IT – L'essenzialità come raffinata scelta stilistica, ovvero il massimo risultato con il minimo numero di elementi. Pochi pezzi attentamente scelti, danno vita a una composizione caratterizzata da un gioco studiato di vuoti e di pieni, spessori sottili e generosi, tonalità complementari che si richiamano ad archetipi della natura e della memoria.

EN – Understatement as a refined design option, i.e. the maximum result with the minimum number of elements. A few, carefully chosen pieces create a composition featuring a studied play on empty and solid, slim and generous thicknesses, with complementary colours which reference archetypes of nature and the past.



Finiture / Finishes

Frassino Ossidato, laccato opaco Argilla.
Maniglia Tratto, Push-Pull / Ossidato Ash,
Argilla matte lacquer finish. Push-Pull
Tratto handle

Elementi / Elements

Panca sistema Pallade P 420 mm, basi sospese
P 420 mm, pensili P 350 mm, elementi in metallo
Lanny P 250 mm / Pallade system bench D 420
mm, wall-mounted base units D 420 mm, wall
units D 350 mm, Lanny metal modules D 250 mm

Dimensioni / Dimensions

L 3750 × H 1760 P 350 – 420 mm





Dettaglio elemento a giorno Lanny in metallo laccato opaco Argilla
/Lanny open unit detail in Argilla matte lacquer finish metal



Day 03

IT – Quando l'arredo si integra completamente nell'architettura, lo spazio domestico diventa uno scenario aperto e luminoso, abitato da raffinati accostamenti di volumi geometrici e linee sottili. Luci ed ombre sembrano impersonare la materia dell'abitare, rivelando una sapiente cultura del progetto.

EN – When the furniture is fully integrated within the architecture, the home space becomes an open and luminous scenario inhabited by sophisticated combinations of geometric volumes and slim lines. Lights and shadows seem to impersonate the essence of the home, revealing an expert design culture.

Finiture/Finishes

Laccato opaco Titanio, laccato opaco Artico. Maniglia Push-Pull/Titanio matte lacquer finish, Artico matte lacquer finish. Push-Pull handle

Elementi/Elements

Basi a terra P 420 mm, vassoio, pensile a ribalta P 350 mm, casellari Unit in metallo /Floor base units D 420 mm, tray, drop-down wall unit D 350 mm, metal Unit open shelves

Dimensioni/Dimensions

L 3300 x H 1850 P 420 – 350 mm







Dettaglio casellari Unit in metallo laccato opaco Artico
/Detail of Unit open shelves in Artico matte lacquer finish metal

Day 04

IT – Seducenti venature, messe in evidenza da un particolare trattamento della materia lignea, diventano un sinuoso e caratterizzante motivo grafico che si rincorre sulle superfici dell'arredo. Un elemento fortemente caratterizzante, per dare vita a uno spazio prestigioso nell'essenza.

EN – Attractive veining, highlighted by a special treatment of the wood, becomes a sinuous and significant graphic motif running over the surfaces of the furniture. A highly distinctive element to create an essentially prestige space.

Finiture/Finishes

Laccato opaco Tufo, cemento Ghisa, Frassino Cotto. Maniglia Push-Pull /Tufo matte lacquer finish, Ghisa concrete, Cotto Ash. Push-Pull handle

Elementi/Elements

Pensili con ante battenti P 350 – 420 mm, casellari Cube in Frassino Cotto, consolle sospesa P 420 mm con elementi Strema a giorno e cassetti in cuoio / Wall units with hinged doors D 350 – 420 mm, Cube open shelves in Cotto Ash, wall-mounted console D 420 mm with open Strema modules and drawers in leather

Dimensioni/Dimensions

L 3000 × H 1650 P 420 – 350 mm







Dettaglio finitura cemento Ghisa su frontali pensili
/Detail of Ghisa concrete finish on wall unit fronts



Dettaglio tavolo Luis con struttura in metallo verniciato Brunito, piano in Frassino Cotto, sedie Fanny
/Detail of Luis table with Brunito coated metal structure, top in Cotto Ash, Fanny chairs

Day 05

IT – Completamente giocata sull'orizzontalità degli elementi pensili, questa versatile composizione parla un linguaggio cromatico e materico fresco, naturale, luminoso. Contenitori e vani a giorno permettono di creare un'organizzazione dello spazio su misura per ogni esigenza, trovando sempre una collocazione ideale.

EN – Fully played out on the horizontal nature of the wall modules, this versatile composition speaks a fresh, natural, luminous language of colour and material. Open compartments and storage units allow made-to-measure space to be organised for every need, always finding the best place.



Finiture/Finishes

Laccato opaco Piombo, Frassino Ossidato.
Maniglia Virgo, Push-Pull/Piombo matte
lacquer finish, Ossidato Ash. Push-Pull
Virgo handle

Elementi/Elements

Basi sospese P 420 – 500 mm, pensile apertura
vasistas P 350 mm, casellari Air con anta
scorrevole in luce/Wall-mounted base units
D 420 – 500 mm, wall unit with transom
opening D 350 mm, Air open shelves with
surface-mounted sliding door

Dimensioni/Dimensions

L 3900 × H 1850 P 500 – 420 – 350 mm







Dettaglio base sospesa sporgente P 500 mm con maniglia Virgo
/ Detail of projecting wall-mounted base unit D 500 mm, with Virgo handle

Day 06

IT – Si potrebbe definire minimal chic, questa composizione di pensili con ampia base orizzontale e contenitori con vani a giorno ed ante a vetro, in un sapiente e raffinato gioco di profili, rientranze, vani e superfici. Un'architettura leggiadra che arreda lo spazio giorno con una presenza raffinata, ma al tempo stesso incisiva e ricca di personalità.

EN – This composition of wall units with large horizontal base unit and storage units with open compartments and glass doors could be defined as minimal chic, in a skilful and artful play on profiles, recesses, compartments and surfaces. An airy architecture which furnishes the living area with a sophisticated yet at the same time decisive presence, with a rich personality.

Finiture / Finishes

Laccato opaco Terra, Frassino Cuoio, vetro Tessutato. Maniglia Push-Pull/Terra matte lacquer finish, Cuoio Ash, Tessutato glass. Push-Pull handle

Elementi / Elements

Basi sospese P 420 mm, elementi Strema a giorno e cassetto in cuoio, pensili con anta vetro Glass P 350 mm, elementi in metallo Grafic P 280 mm / Wall-mounted base units D 420 mm, with open Strema modules and drawers in leather, wall units with Glass door D 350 mm, Grafic metal modules D 280 mm

Dimensioni / Dimensions

L 3750 × H 1650 P 350 – 420 mm







Dettaglio elemento a giorno Grafic in metallo laccato opaco Terra con ripiani impiallacciati Frassino Cuoi e pensile con anta Glass vetro Tessutato/Detail of Grafic open unit in Terra matte lacquer finish metal with Cuoi Ash veneered shelves and wall unit with Glass door in Tessutato glass

Day 07

IT – Citazioni vintage e modernità senza tempo, per questa composizione caratterizzata dalla forte presenza della base, con contenitori laterali a loro volta contraddistinti da maniglie decisamente originali nel design. Un fresco abbinamento cromatico, contribuisce a trasmettere un senso di dinamismo e di informalità nello stile di vita.

EN – Vintage references and timeless modernity for this composition featuring the strong presence of the base unit with side storage units in turn featuring handles with a decidedly original design. Fresh colour coordination goes to convey a sense of dynamism and informality in the style of living.



Finiture / Finishes

Frassino Carbone, laccato opaco Muschio.
Maniglia Piolo, Push-Pull / Carbone Ash,
Muschio matte lacquer finish.
Push-Pull Piolo handle

Elementi / Elements

Panca sistema Pallade P 420 mm, basi sospese
P 420 mm, pensili P 350 mm, elementi Accordo
a giorno / Pallade system bench D 420 mm,
wall-mounted base units D 420 mm, wall units
D 350 mm, Accordo open units

Dimensioni / Dimensions

L 3600 × H 1600 P 350 – 420 mm





Dettaglio maniglia Piolo brunita
/Detail of burnished Piolo handle



Dettaglio grafico composto da pensili con anta ed elemento Accordo a giorno
/Graphic detail made up of wall units with door and Accordo open unit

1

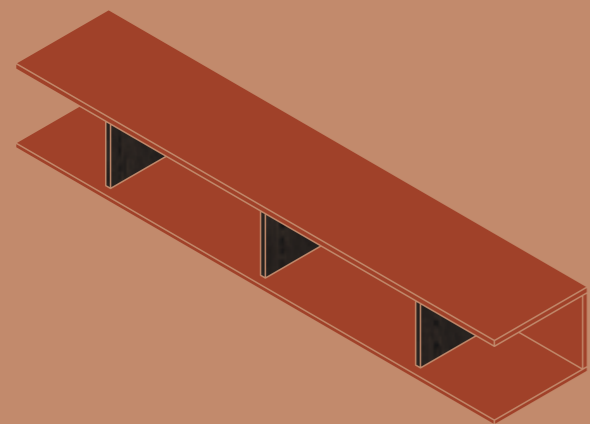

2

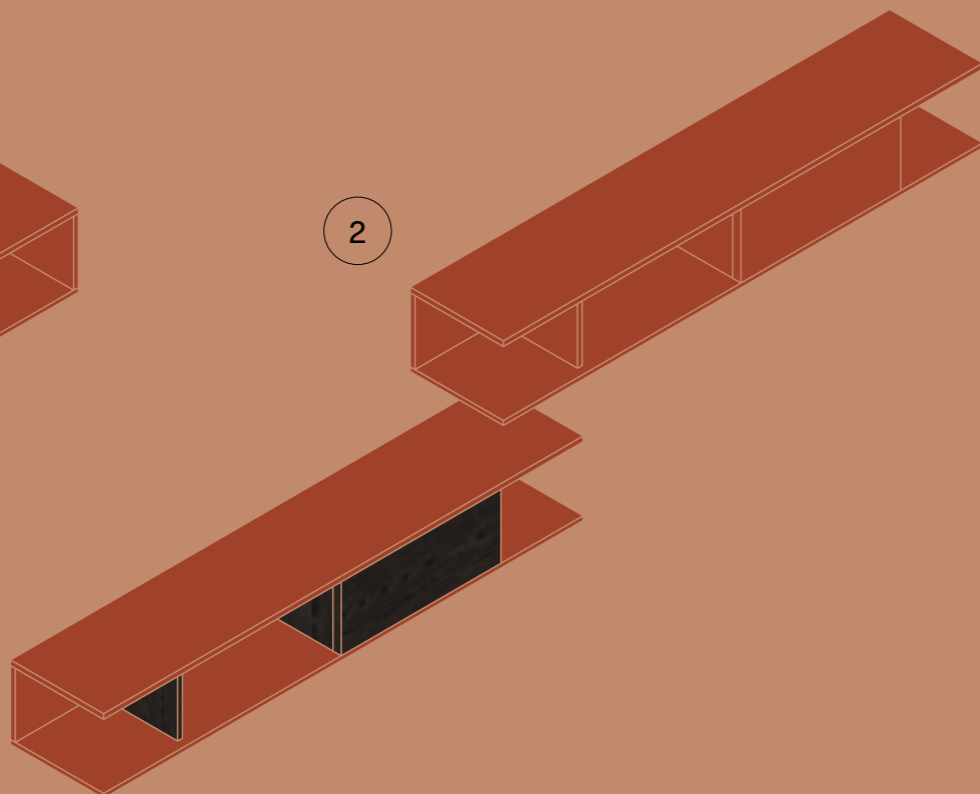

3



4

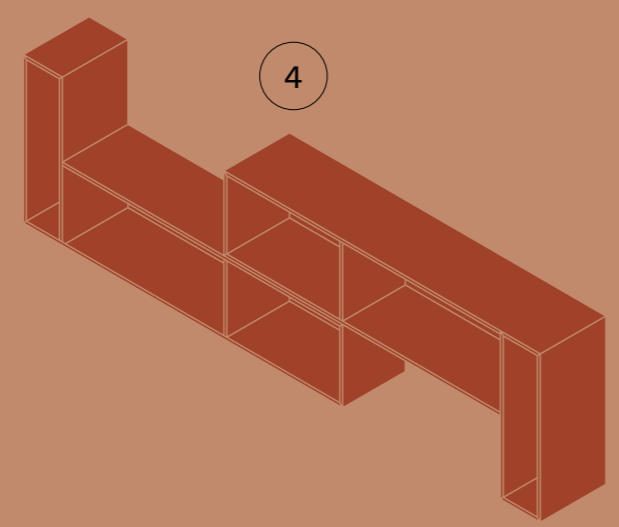

1. Casellario Air

2. Casellario Air con anta scorrevole

3. Casellario Cube

4. Casellario Accordo

Day 08

IT – Forti spessori, ampie superfici e tonalità che non passano inosservate, per una composizione che si impone come una protagonista dell'ambiente giorno, pur mantenendo un armonioso equilibrio con lo spazio architettonico e con gli altri elementi dell'arredo.

EN – Extra thicknesses, large surfaces and colours which don't go unnoticed, for a composition which stands out as key feature of the living area, while maintaining a harmonious balance with the architectural space and the other items of furniture.

Finiture / Finishes

Laccato opaco Artico, laccato opaco Ecrù.
Maniglia Push-Pull / Artico matte lacquer finish,
Ecrù matte lacquer finish. Push-Pull handle

Elementi / Elements

Basi sospese P 420 mm, panca sistema Pallade
P 420 mm, pensili P 350 mm, casellari Cube
/Wall-mounted base units D 420 mm, Pallade
system bench D 420 mm, wall units D 350 mm,
Cube open shelves

Dimensioni / Dimensions

L 3750 × H 1600 P 420 – 350 mm







Day 09

IT – Ogni elemento di questo scenario domestico sembra raccontare una storia affascinante e senza tempo, fatta di raffinati accostamenti, linee sottili, luminosità e trasparenze soffuse. Le venature del legno aggiungono un tocco di naturalezza, interpretata con uno spirito contemporaneo.

EN – Every element of this domestic scene appears to tell a fascinating and timeless story, made up of sophisticated coordination, slim lines, light and suffused transparencies. The veins of the wood add a natural touch, interpreted with a contemporary spirit.

Finiture/Finishes

Laccato opaco Titanio, Frassino Cotto, laccato opaco Fulvo. Maniglia Tratto /Titanio matte lacquer finish, Cotto Ash, Fulvo matte lacquer finish. Tratto handle

Elementi/Elements

Basi sospese P 420 mm, vassoio, pensili Grafic P 280 mm /Wall-mounted base units D 420 mm, tray, Grafic wall units D 280 mm

Dimensioni/Dimensions

L 3600 × H 1850 P 420 – 350 mm







Dettaglio palo porta TV, attacco USB, vassoio portaoggetti
/Detail of TV support post, USB socket, display tray



Dettaglio casellari Grafic in metallo laccato Fulvo con ripiani e schiene in Frassino Cotto
/Detail of Grafic open shelves in Fulvo lacquer finish metal with shelves and backs in Cotto Ash

Finiture/Finishes

Frassino Cotto, vetro trasparente
/Cotto Ash, clear glass

Elementi/Elements

Madia Glass con basamento Erica
verniciato Brunito/Glass sideboard
with Erica base with Brunito coating

Dimensioni/Dimensions

L 1200 x H 1592 P 500 mm



Dettaglio madia Glass aperta con interno elemento a cassetti in
cuoio in finitura Cognac/Detail of open Glass sideboard with interior
drawers unit in leather with Cognac finish

Day 10

IT – Un classico sempre di attualità. L'abbinamento fra l'essenza e la tonalità laccata, viene giocato in una composizione di volumi sospesi e di forti spessori, dominata da un solido e razionale senso dell'ordine che non rinuncia a un piacevole dinamismo.

EN – A classic example of modernity. The combination of the wood and lacquer finish colour is played out in a composition of wall-mounted volumes and extra thicknesses, dominated by a solid and rational sense of order which never foregoes a pleasing dynamism.



Finiture/Finishes

Laccato opaco Oliva, Frassino Ossidato.
Maniglia Push-Pull/Oliva matte lacquer
finish, Ossidato Ash. Push-Pull handle

Elementi/Elements

Basi sospese P 420 mm panca sistema Pallade
P 420 mm, pensili a ribalta e vasistas P 350 mm.
Mensole Snake P 250 mm / Wall-mounted
base units D 420 mm, Pallade system bench
D 420 mm, drop-down and transom wall units
D 350 mm. Shelves Snake D 250 mm

Dimensioni/Dimensions

L 3300 × H 1890 P 420 – 350 mm





Dettaglio base sospesa con cassettone aperto e frontale Rombo laccato opaco Oliva / Detail of wall-mounted base unit with open large drawer and Rombo front in Oliva matte lacquer finish

Day 11

IT – La libreria bifacciale suddivide efficacemente lo spazio giorno, senza creare barriere e mantenendo la sua fruibilità da entrambi i lati. In perfetta affinità cromatica e stilistica, una soluzione per il living che riunisce la TV, l'area espositiva e i contenitori pensili in un'unica, coerente e lineare composizione.

EN – The two-sided bookcase effectively divides up the living area, without creating barriers and maintaining possible use on both sides. In perfect colour and style affinity, a solution for the living area which brings together the TV, display area and wall-mounted storage units in a single, coherent and linear composition.



Finiture/Finishes

Laccato opaco Argilla, laccato opaco Ortensia, laccato opaco Perla. Maniglia Virgo, Push-Pull/Argilla matte lacquer finish, Ortensia matte lacquer finish, Perla matte lacquer finish. Push-Pull Virgo handle

Elementi/Elements

Basi a terra P 420 mm, consolle sistema Pallade P 420 mm, pensili con frontali Rombo P 350 mm, elemento Raster P 270 mm/Floor-standing base units D 420 mm, Pallade system console D 420 mm, wall units with Rombo fronts D 350 mm, Raster module D 270 mm

Dimensioni/Dimensions

L 4050 × H 1650 P 420 – 350 mm





Dettaglio grafico elemento Raster a giorno in P 270 mm laccato opaco Argilla
/Graphic detail of open Raster module with D 270 mm, Argilla matte lacquer finish



Dettaglio frontali pensili Rombo laccati opachi Perla
/Detail of Rombo wall unit fronts, Perla matte lacquer finish



Dettaglio base a terra P 420 mm con cassettone aperto, maniglia Virgo
/Detail of floor-standing base unit D 420 mm, with open large drawer and Virgo handle

Day 12

IT – Verticalità e orizzontalità si incontrano, in questa composizione che risolve lo spazio giorno con una certa originalità, pur mantenendo una gradevole compostezza stilistica. Linee e volumi sfalsati creano un gioco ritmico che contribuisce a infondere personalità all'intero ambiente.

EN – The vertical and the horizontal come together in this composition which defines the living area with a certain originality, while maintaining a pleasing stylistic restraint. Staggered volumes and lines create a rhythmic play which goes to instil personality in the entire living area.



Finiture/Finishes

Laccato opaco Titanio, laccato opaco Cannella.
Maniglia Push-Pull/Titanio matte lacquer finish,
Cannella matte lacquer finish. Push-Pull handle

Elementi/Elements

Basi a terra P 420 mm, pensili P 350 mm,
casellari Unit P 250 mm/Floor-standing base
units D 420 mm, wall units D 350 mm,
Unit open shelves D 250 mm

Dimensioni/Dimensions

L 3000 × H 1850 P 420 – 250 mm





Dettaglio casellari Unit in metallo laccato opaco Cannella
/Detail of Unit open shelves in Cannella matte lacquer finish metal

Finiture/Finishes

Laccato opaco Tufo, laccato opaco Cannella/Tufo matte lacquer finish, Cannella matte lacquer finish

Elementi/Elements

Madia Glass con basamento Tiglio verniciato Brunito/Glass sideboard with Tiglio base with Brunito coating

Dimensioni/Dimensions

L 1200 x H 1224 P 420 mm



Dettaglio piano tavolo Luis in marmo Grigio Oriente
/Detail of Luis table top in Grigio Oriente marble



Dettaglio anta Glass con pannello laccato opaco Cannella
/Detail of Glass door with Cannella matte lacquer finish panel

Day 13

IT – Il legno, interpretato con una particolare finitura, è il protagonista di uno spazio giorno prestigioso, nel quale la modernità si trasforma in una dimensione senza tempo, raggiungendo una perfetta integrazione fra l'arredo, la tecnologia e l'architettura.

EN – The wood, interpreted with a special finish, is the key feature in a high-end living area in which modernity becomes a timeless dimension, achieving perfect integration between furniture, technology and architecture.



Finiture/Finishes

Frassino Carbone, laccato opaco
Pino. Maniglia Virgo, Push-Pull
/Carbone Ash, Pino matte lacquer finish. Push-Pull Virgo handle

Elementi/Elements

Basi a terra P 420 mm, basi sospese in appoggio
P 500 mm, pensili a ribalta e vasistas P 350 mm,
casellari Grafic P 280 mm / Floor-standing base
units D 420 mm, resting wall-mounted base units
D 500 mm, drop-down and transom wall units
D 350 mm, Grafic open shelves D 280 mm

Dimensioni/Dimensions

L 3900 × H 1765 P 500 – 420 – 350 – 280 mm





Dettaglio base sospesa P 500 mm con frontale apertura ribalta e meccanismo a filo
/Detail of wall-mounted base unit D 500 mm, with drop-down opening front and flush mechanism



Dettaglio casellari Grafic in metallo laccato opaco Pino, con piani e schienali laccati opachi Pino
/Detail of Grafic open shelves in Pino lacquer finish metal with shelves and backs in Pino matte lacquer finish

Day 14

IT – Tonalità naturali, volumi essenziali e forti spessori, per uno spazio giorno che sembra emanare un senso di serenità, una raggiunta armonia interiore che si riflette nella disposizione degli elementi dell'arredo. Il risultato è un ambiente positivo, elegante ed accogliente.

EN – Natural colours, understated volumes and extra thicknesses, for a living area which appears to emanate a sense of serenity, the achievement of inner harmony which is reflected in the arrangement of the items of furniture. The result is a positive space, elegant and welcoming.

104 – 105



Finiture/Finishes

Laccato opaco Caramello, Frassino
Cuoio, laccato opaco Terra. Maniglia Tratto,
Push-Pull/Caramello matte lacquer finish,
Cuoio Ash, Terra matte lacquer finish.
Push-Pull Tratto handle

Elementi/Elements

Panca sistema Pallade P 420 mm,
basi sospese P 420 mm, pensili a ribalta
e vasistas P 350 mm, casellari Unit in
metallo laccato/Pallade system bench
D 420 mm, wall-mounted base units D 420 mm,
drop-down and transom wall units D 350 mm,
Unit open shelves in lacquer finish metal

Dimensioni/Dimensions

L 3750 × H 1650 P 420 – 350 mm





Dettaglio casellari Unit in metallo laccato Terra
/Detail of Unit open shelves in Terra matte lacquer finish metal



Dettaglio panca sistema Pallade P 420 mm con basi sospese maniglia Tratto
/Detail of Pallade system bench D 420 mm, wall-mounted base units with Tratto handle

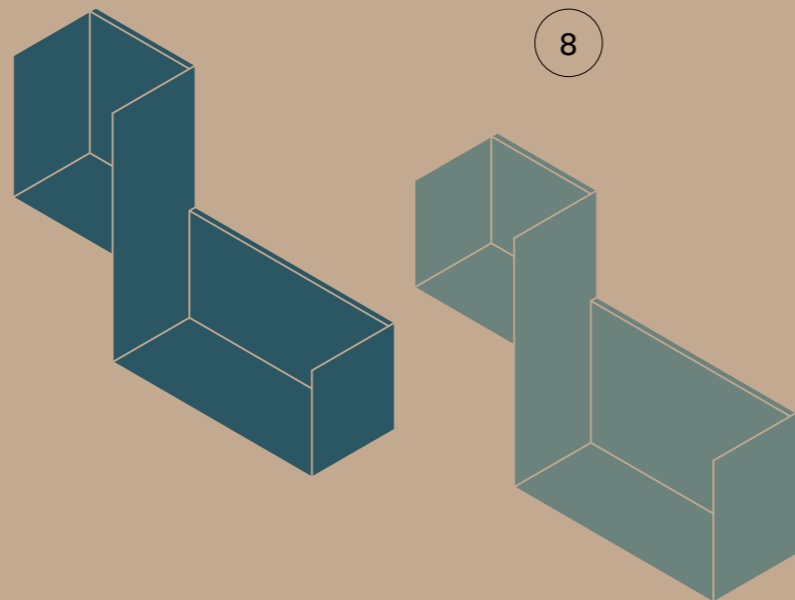
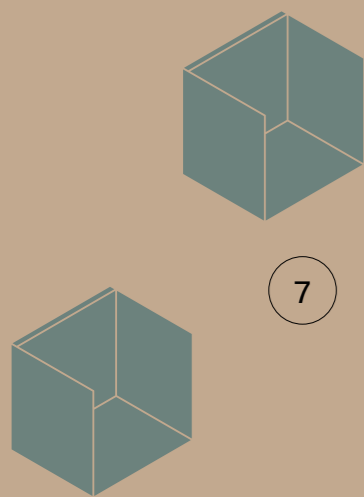
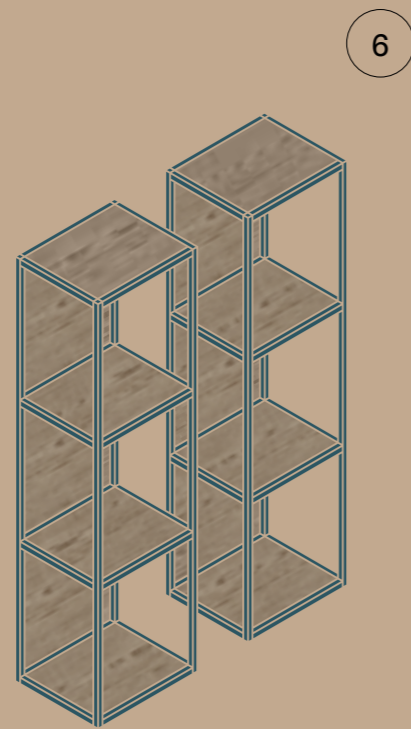
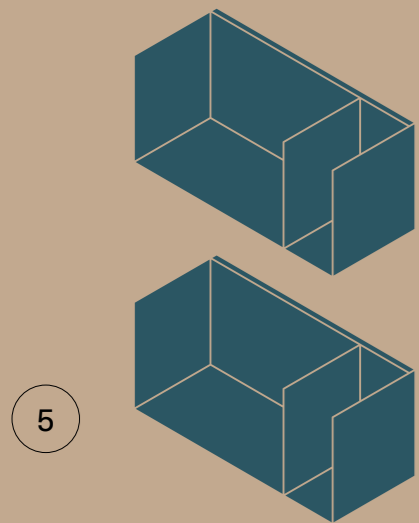



Day 15

IT – Ispirazioni nordiche per una soluzione che abbina essenze e tonalità particolarmente luminose, ricercando una funzionale essenzialità senza rinunciare alla qualità estetica. La libreria bifacciale orizzontale suddivide lo spazio e permette di organizzare un microcosmo di libri e oggetti, senza creare barriere visive.

EN – Nordic inspirations for a solution which combines particularly luminous colours and wood types, seeking out a functional understatement yet without abandoning aesthetic quality. The horizontal two-sided bookcase divides up the space and allows a microcosm of books and objects to be organised without creating visual barriers.

Finiture/Finishes

Laccato opaco Piuma, Frassino Ossidato, laccato opaco Terra. Maniglia Lateral, Push-Pull/Piuma matte lacquer finish, Ossidato Ash, Terra matte lacquer finish. Push-Pull Lateral handle

Elementi/Elements

Base a terra P 420 mm, consolle sospesa P 420 mm, pensili a ribalta e vasistas P 350 mm, casellario Air/Floor-standing base unit D 420 mm, wall-mounted console D 420 mm, drop-down and transom wall units D 350 mm, Air open shelf

Dimensioni/Dimensions

L 3900 × H 1900 P 420 – 350 mm





Dettaglio casellario Air a giorno
/ Detail of Air open shelf



Dettaglio base a terra con cassettone aperto, maniglia Lateral
/Detail of floor-standing base unit with open large drawer, Lateral handle

**Finiture/Finishes**

Laccato opaco Piuma, Frassino Ossidato,
laccato opaco Terra/Piuma matte lacquer finish,
Ossidato Ash, Terra matte lacquer finish

Elementi/Elements

Libreria orizzontale bifacciale con
elementi pensili per vano libreria
/Two-sided horizontal bookcase with
modules for bookcase space

Dimensioni/Dimensions

L 2730 x H 1507 P 478 mm

Day 16

IT – L'incontro fra le venature del legno, evidenziate da una particolare lavorazione, ed un fresca tonalità floreale, caratterizza questa composizione improntata a un piacevole equilibrio di volumi pieni e linee sottili. La tecnologia si integra con intelligenza nel design, soddisfacendo le esigenze del presente.

EN – The coming together of the veins of the wood, underscored by a special process, and a fresh floral colour are features of this composition based on a pleasing balance of solid volumes and slim lines. The technology is integrated with intelligence in the design, fulfilling present needs.

Finiture/Finishes

Laccato opaco Ortensia, Frassino Cotto, laccato opaco Antracite. Maniglia Push-Pull /Ortensia matte lacquer finish, Cotto Ash, Antracite matte lacquer finish. Push-Pull handle

Elementi/Elements

Basi sospese P 420 mm, casellari Fanny P 250 mm, pensili a ribalta P 350 mm /Wall-mounted base units D 420 mm, Fanny open shelves D 250 mm, drop-down wall units D 350 mm

Dimensioni/Dimensions

L 3900 × H 1600 P 420 – 250 mm







Dettaglio sistema passacavi su base sospesa per TV
/Detail of cable duct system on wall-mounted base for TV



Dettaglio attacco Wireless su base sospesa
/Detail of wireless charger on wall-mounted base



Dettaglio compositivo casellari Fanny a giorno in metallo laccato Antracite e schiena Frassino Cotto, con pensili a ribalta
/Detail of composition of open Fanny shelves in Antracite lacquer finish metal and Cotto Ash back, with drop-down wall units



Day 17

IT – L'eleganza è di rigore, in uno spazio giorno accogliente ma al tempo stesso raffinato, nel quale dominano le scure profondità del legno e la chiara trasparenza del vetro. Un abbinamento che fa da cornice ad una moltitudine di oggetti e libri preziosi, espressione di una profonda cultura dell'abitare.

EN – Elegance is de rigueur, in a welcoming yet at the same sophisticated living area, in which the dark depths of the wood and the clear transparency of the glass dominate. A combination which forms the setting for myriad objects and valuable books, manifestation of a profound culture of living.

Finiture/Finishes

Frassino Carbone, laccato opaco Piombo, vetro Trasparente. Maniglia Lateral
/Carbone Ash, Piombo matte lacquer finish, Trasparente glass. Lateral handle

Elementi/Elements

Sistema boiserie a parete con illuminazione dietro, base a terra P 420 mm, consolle P 420 mm, pensili anta Glass con vetro trasparente, mensole in metallo per boiserie
/Wall panelling system with back lighting, floor-standing base unit D 420 mm, console D 420 mm, Glass door wall units with clear glass, metal shelves for wall panelling

Dimensioni/Dimensions

L 3600 × H 1997 P 420 – 350 mm





Dettaglio mensola in metallo per boiserie, laccato opaca Piombo
/Detail of metal shelf for wall panelling, with Piombo matte lacquer finish



Dettaglio pensili anta telaio Glass con vetro Trasparente, apertura a ribalta con meccanismo a filo
/Detail of wall units with Glass frame door and Trasparente glass, drop-down opening with flush mechanism



Finiture/Finishes
Frassino Carbone, vetro Trasparente
/Carbone Ash, Trasparente glass

Elementi/Elements
Madia Glass con basamento Kako
verniciato Brunito/Glass sideboard with
Kako base with Brunito coating

Dimensioni/Dimensions
L 2400 x H 756 P 420 mm



Day 18

IT – Ispirazioni vintage e moderne possibilità di utilizzo e ambientazione, per una proposta semplice e funzionale, giocata sull'abbinamento fra una rilassante tonalità laccata e una luminosa essenza chiara. Pensili e mensole creano un insieme essenziale, fedele al concetto di base del design: "less is more".

EN – Vintage inspirations and modern possibilities of use and setting, for a simple and functional offering played out on the combination of a relaxing lacquer finish palette and clear and luminous wood. Wall units and shelves create an understated whole, true to the basic design concept of "less is more".

140 – 141

Finiture / Finishes

Frassino Ossidato, laccato opaco Indaco, laccato opaco Nebbia. Maniglia Push-Pull / Ossidato Ash, Indaco matte lacquer finish, Nebbia matte lacquer finish. Push-Pull handle

Elementi / Elements

Basi in appoggio P 420 mm su basamento Lama, pensile con cassetto P 420 mm, libreria Raster, pensile a ribalta P 350 mm / Floor-standing base units D 420 mm on Lama base, wall unit with drawer D 420 mm, Raster bookcase, drop-down wall unit D 350 mm

Dimensioni / Dimensions

L 3900 × H 1650 P 420 – 350 mm







Dettaglio pensile P 420 mm con cassetto aperto
/ Detail of wall unit D 420 mm, with open drawer



Dettaglio base in appoggio su basamento Lama con frontale a ribalta aperto e meccanismo a filo
/Detail of base unit resting on Lama base with open drop-down front and flush mechanism



Day 19

IT – Un minimalismo estremamente raffinato, nel quale pochi elementi regnano sovrani nello spazio. Il pensile con presa USB e il classificatore, portano nell'ambiente un tocco di tecnologia, per uno stile di vita dinamico e attivo. La vetrina con venature in evidenza, ha un sapore decisamente museale e prestigioso.

EN – An extremely sophisticated minimalism in which a few elements reign supreme in the space. The wall unit with USB socket and the open shelf add a touch of technology to the room, for a dynamic and active lifestyle. The glass cabinet with exposed veins has a decidedly museum, prestigious flavour.

Finiture/Finishes

Laccato opaco Pino, Frassino Cotto, laccato opaco Tufo, vetro Trasparente.
Maniglia Push-Pull/Pino matte lacquer finish, Cotto Ash, Tufo matte lacquer finish, Trasparente glass. Push-Pull handle

Elementi/Elements

Pensile con cassetto P 420 mm, casellari
 Unit in metallo laccato, Teke in vetro con ante
 Glass vetro trasparente/Wall unit with
 drawer D 420 mm, Unit open shelves in lacquer
 finish metal, Teke in glass with Glass doors
 in clear glass

Dimensioni/Dimensions

L 1800 P 420 – 250 mm





Dettaglio pensile P 420 mm con attacco USB, casellario Unit in metallo laccato opaco Tufo e schiena in Frassino Cotto / Detail of wall unit D 420 mm with USB socket, Unit open shelf in Tufo matte lacquer finish metal and back in Cotto Ash

Day 20 Logico
pagina 156 › 165

Day 26 Logico
pagina 206 › 213

Day 21 Logico
pagina 166 › 171

Day 27 Logico
pagina 214 › 219

Day 22 Logico
pagina 172 › 177

Day 28 Logico
pagina 222 › 229

Day 23 Logico
pagina 178 › 185

Day 29 Logico
pagina 230 › 237

Day 24 Logico
pagina 188 › 195

Day 30 Logico
pagina 238 › 245

Day 25 Logico
pagina 196 › 205

Day 31 Logico
pagina 246 › 251

Capitolo N°2

Collection Day – Logico

Day 20

IT – La libreria diviene una parte integrante dell'architettura d'interni, generando una composizione di importanti dimensioni che organizza e caratterizza l'intero spazio. La componibilità e la modularità sono strumenti per creare infinite soluzioni, con uno stile coerente nelle finiture, nei colori e nei materiali.

EN – The bookcase becomes an integral part of the interior architecture, creating a composition which is large in size and organises and styles the entire space. The composition possibilities and modularity are instruments for creating infinite solutions, with a coherent style in the finishes, colours and materials.

156 – 157

Finiture / Finishes

Frassino Carbone, laccato opaco Muschio, vetro Tessutato. Maniglia Push-Pull / Carbone Ash, Muschio matte lacquer finish, Tessutato glass. Push-Pull handle

Elementi / Elements

Libreria a parete e bifacciale, vano porta TV con anta Glass scorrevole. Divisori in vetro Bronzato / Two-sided and wall bookcase with TV unit with sliding Glass door. Partitions in Bronzato glass

Dimensioni / Dimensions

L 3358 x 5158 H 1875 P 350 mm







Dettaglio anta scorrevole Glass con vetro Tessutato per vano porta TV
/Detail of Glass sliding door with Tessutato glass for TV unit



Dettaglio vetro Tessutato
/Detail of Tessutato glass



Dettaglio ripiani in vetro Bronzato per vani libreria e divisioni verticali in legno spessore 12 mm laccati opachi Muschio
/Detail of shelves in Bronzato glass for bookcase spaces and vertical divisions in wood, thickness 12 mm, Muschio lacquer finishes



Day 21

IT – Il piacere dell'ordine e dell'armonia, in una composizione che interpreta schemi classici, con un tocco di attualità in più, anche grazie all'effetto creato dall'illuminazione integrata. Lineare e adatta a inserirsi negli spazi più diversi, grazie alla sua modularità, questa soluzione si veste di tonalità ed essenze che vanno oltre il tempo e le mode.

EN – The pleasure of order and harmony in a composition which interprets classical patterns with an added contemporary touch, also thanks to the effect created by the built-in lighting. Linear and suitable for being installed in the most widely differing spaces, thanks to its modularity, this solution is dressed in colours and wood types which go beyond time and trends.



Finiture/Finishes

Frassino Cotto, Laminat Apollo, laccato opaco Ecrù. Maniglia Tratto/Cotto Ash, Laminat Apollo, Ecrù matte lacquer finish. Tratto handle

Elementi/Elements

Libreria a parete, libreria a ponte e sovrapposta P 350 mm, Teka in vetro con ante Glass, basi a terra P 420 mm / Wall bookcase, bridge and superstructure bookcase D 350 mm, Teka in glass with Glass doors, floor base units D 420 mm

Dimensioni/Dimensions

L 4260 × H 1875 P 350 – 420 mm





Dettaglio Teka con ante Glass vetro trasparente, con schiena Laminat Apollo, ripiano in cristallo Bronzato e illuminazione LED
/Detail of Teka with Glass doors in clear glass, with Laminat Apollo back, shelf in Bronzato crystal and LED lighting



Dettaglio anta ribalta aperta con maniglia Tratto
/Detail of open drop-down door with Tratto handle



Day 22

IT – Osare abbinamenti fra venature naturali e tonalità di sapore industriali, in un contesto architettonico dominato dalla luminosità e dalla trasparenza. Gli arredi sono elementi di un progetto globale di vita, un concetto dell'abitare come espressione di libertà interiore.

EN – Daring combinations of natural veining and colours with an industrial flavour in an architectural context dominated by light and transparency. The furniture represents elements of a global life project, a lifestyle concept as an expression of inner freedom.

Finiture/Finishes

Laccato opaco Cannella, Frassino Ossidato
/Cannella matte lacquer finish, Ossidato Ash

Elementi/Elements

Libreria orizzontale con vano console, divisori in metallo laccato Cannella per vani libreria/Horizontal bookcase with console compartment, partitions in Cannella lacquer finish metal for bookcase spaces

Dimensioni/Dimensions

L 1830 × H 2611 P 350 – 420 mm

Finiture / Finishes

Laccato opaco Cannella, Frassino Ossidato
/Cannella matte lacquer finish, Ossidato Ash

Elementi / Elements

Madia Glass con basamento Dalia
verniciato Brunito / Glass sideboard with
Dalia base with Brunito coating

Dimensioni / Dimensions

L 2400 x H 756 P 420 mm



Dettaglio divisorio in metallo laccato Cannella per vani libreria
/ Detail of partition in Cannella lacquer finish metal for bookcase spaces



Dettaglio ante telaio Glass finitura Brunito, con pannello Frassino Ossidato
e basamento Dalia verniciato Brunito / Detail of Glass frame doors with
Brunito finish, with Ossidato Ash panel and Dalia base with Brunito coating



Day 23

IT – Libreria, zona TV e spazi dedicati al contenimento, sono riuniti in un'unica soluzione, ideale per una molteplicità di spazi, situazioni e scenari. La maniglia Tratto, come uno segno grafico, aggiunge una nota stilistica al piacevole abbinamento cromatico scelto per la composizione.

EN – Bookcase, TV area and spaces given over to storage are brought together in a single solution, ideal for multiple spaces, situations and scenarios. The Tratto handle, like a graphic sign, adds a design note to the pleasing colour combination chosen for the composition.

Finiture/Finishes

Laccato opaco Perla, laccato opaco Titanio, cemento Siena. Maniglia Tratto, Push-Pull / Perla matte lacquer finish, Titanio matte lacquer finish, Siena concrete. Push-Pull Tratto handle

Elementi/Elements

Libreria a parete P 350 mm, libreria sovrapposta e ponte libreria per vano TV P 350 mm, basi a terra P 500 mm / Wall bookcase D 350 mm, superstructure bookcase and bridge bookcase for TV unit D 350 mm, floor-standing base units D 500 mm

Dimensioni/Dimensions

L 4260 × H 1875 P 350 – 500 mm





Dettaglio vano libreria con ripiani in vetro Bronzato e illuminazione a LED
/Detail of bookcase space with shelves in Bronzato glass and LED lighting



Dettaglio finitura cemento Siena su frontali libreria e maniglia Tratto
/Detail of Siena concrete finish on bookcase fronts and Tratto handle



Dettaglio base a terra con cassettone aperto
/Detail of floor-standing base unit with open large drawer

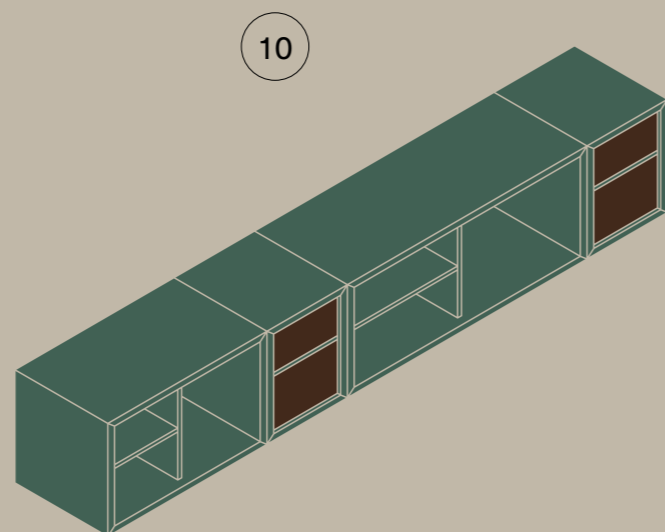
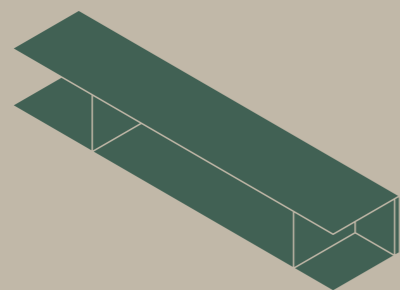
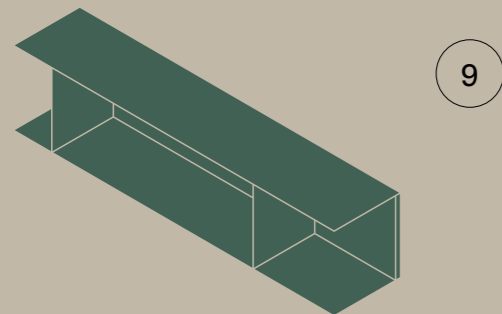

11

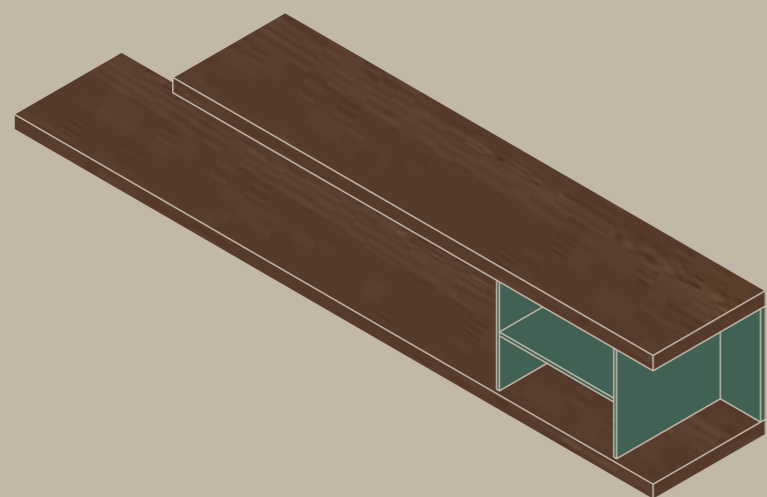

12

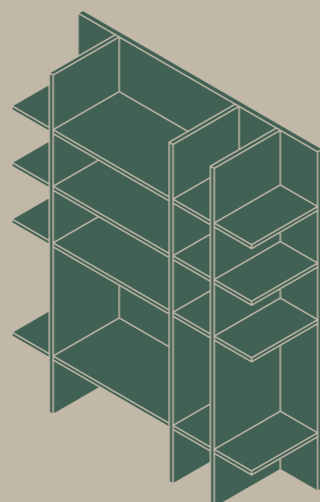

Day 24

IT – Il solido prestigio dell'essenza, si accompagna alla leggiadra tonalità laccata, in una soluzione che esprime un piacevole senso di tranquillità e benessere. Il vetro bronzato, con i suoi riflessi, rende ancora più preziosa questa composizione, dotata inoltre di vano per la TV con illuminazione integrata.

EN – The solid prestige of wood accompanies the airy lacquer finish colour in a solution that expresses a pleasant sense of calm and well-being. The bronzed glass, with its reflections, adds value to this composition, also with a unit for the TV with built-in lighting.

188 – 189



Finiture/Finishes

Frassino Cotto, laccato opaco Ortensia, vetro Bronzato. Maniglia Tratto/Cotto Ash, Ortensia matte lacquer finish, Bronzato glass. Tratto handle

Elementi/Elements

Libreria a parete con vano porta TV e anta scorrevole Glass/Wall bookcase with TV unit and Glass sliding door

Dimensioni/Dimensions

L 4380 × H 1875 P 350 mm





Dettaglio anta scorrevole Glass con telaio Brunito e vetro Bronzato
/Detail of Glass sliding door with Brunito frame and Bronzato glass



Dettaglio ante battenti Rombo laccate opache Ortensia con maniglia Tratto
/Detail of Rombo side-hinged doors in Ortensia matte lacquer finish with Tratto handle



Dettaglio tavolo fisso Sambuco con sedie Fanny
/Detail of Sambuco fixed table with Fanny chairs



Day 25

IT – Una libreria imponente che veste la parete con una trama di vuoti e di pieni, impreziosita da schienali marmorei, vitree trasparenze, giochi di luce, accessori in cuoio. Tutto questo in una realizzazione di qualità sartoriale, che non trascuria il minimo dettaglio, per rendere straordinaria la vita quotidiana.

EN – An impressive bookcase that covers the wall with a fabric of empty and solid parts, embellished by marble backs, glassy transparencies, plays on light and leather accessories. All this in a product of sartorial quality which does not overlook the smallest detail to make daily living extraordinary.

Finiture/Finishes

Frassino Carbone, laccato opaco Indaco, Laminat Aphrodite/Carbone Ash, Indaco matte lacquer finish, Laminat Aphrodite

Elementi/Elements

Libreria a parete P 328 mm x H 2979 mm, libreria a parete P 478 mm x H 1875 mm, sopra libreria orizzontale P 328 mm x H 1104 mm, divisori per Libreria in metallo laccati/Wall bookcase D 328 mm x H 2979 mm, wall bookcase D 478 mm x H 1875 mm, horizontal superstructure bookcase D 328 mm x H 1104 mm, partitions for bookcase in metal with lacquer finish

Dimensioni/Dimensions

L 5430 x H 2979 P 350 – 478 mm





Dettaglio schiena il Laminat Aphrodite su vani Libreria
/Detail of back in Laminat Aphrodite on bookcase spaces



Dettaglio elemento con cassetti in cuoio su vano interno libreria P 378 mm
/Detail of module with drawers in leather on internal bookcase space D 378 mm



Tavolo consolle Alfred L 1500 × H 735 P 540
/ Alfred console table W 1500 × H 735 D 540



Dettaglio basamento in metallo verniciato Brunito per tavolo consolle Alfred
/Detail of base in Brunito coated metal for Alfred console table

Day 26

IT – Fra i vani a giorno della libreria con porta TV, i contenitori laccati con apertura push-pull rappresentano degli elementi al tempo stesso funzionali e decorativi, come dei volumi pieni all'interno di una griglia grafica. L'ambiente è completato da un pensile con una particolare texture superficiale.

EN – Among the open units of the bookcase with TV unit the lacquer finish storage units with push-pull opening represent elements that are both functional and decorative, like the solid volumes inside a graphic grid. The room is finished off with a wall unit with a special surface texture.



Finiture/Finishes

Frassino Ossidato, laccato opaco Piombo.
 Maniglia Push-Pull/Ossidato Ash, Piombo matte
 lacquer finish. Push-Pull handle

Elementi/Elements

Libreria orizzontale con pensili per
 vano libreria, consolle porta TV, divisori
 in metallo laccato opaco Piombo
 /Horizontal bookcase with wall units for
 bookcase space, TV unit console, partitions
 in Piombo matte lacquer finish metal

Dimensioni/Dimensions

L 3330 × H 2243 P 350 – 420 mm





Dettaglio pensile per vano libreria con apertura vasistas e meccanismo pistoncino
/Detail of wall unit for bookcase space with transom opening and piston mechanism



Dettaglio frontale Rombo laccato opaco Piombo su madia Modulo
/Detail of Rombo front in Piombo matte lacquer finish on Modulo sideboard



Finiture/Finishes
Frontale Rombo laccate opache Piombo
/Rombo front in Piombo matte lacquer finish

Elementi/Elements
Madia Modulo/Modulo sideboard

Dimensioni/Dimensions
L 2700 x H 552 P 420 mm

Day 27

IT – Completamente pensile, come sospesa a mezz'aria su un suggestivo gioco di luce, diffuso verso il basso dal sistema di illuminazione integrato, questa composizione è giocata su tonalità calde e naturali, in sintonia con uno stile di vita raffinatamente contemporaneo. Ante e vani a giorno offrono molteplici possibilità di contenimento, mantenendo una piacevole linearità.

EN – Fully wall-mounted, as if suspended mid air on a fascinating play on light, diffused downwards by the built-in lighting system, this composition is played out on warm and natural tones, in line with a sophisticatedly contemporary lifestyle. Doors and open units offer multiple possibilities of storage while maintaining a pleasingly linear shape.



Finiture/Finishes

Laccato opaco Argilla, Frassino Ossidato.
 Maniglia Virgo, Push-Pull/Argilla matte lacquer
 finish, Ossidato Ash. Push-Pull Virgo [handle](#)

Elementi/Elements

Basi sospese P 420 mm, libreria sospesa
 e sovrapposta P 350 mm/Wall-mounted
 base units D 420 mm, wall-mounted
 and superstructure bookcase D 350 mm

Dimensioni/Dimensions

L 4380 H 1502 P 350 – 420 mm





Dettaglio maniglia Virgo, con profilo laccato opaco Argilla, su anta Frassino Ossidato. Interno vano spalla con ripiani in cristallo Bronzato e illuminazione LED / Detail of Virgo handle with Argilla matte lacquer finish profile on Ossidato Ash door. Side compartment interior with shelves in Bronzato crystal and LED lighting

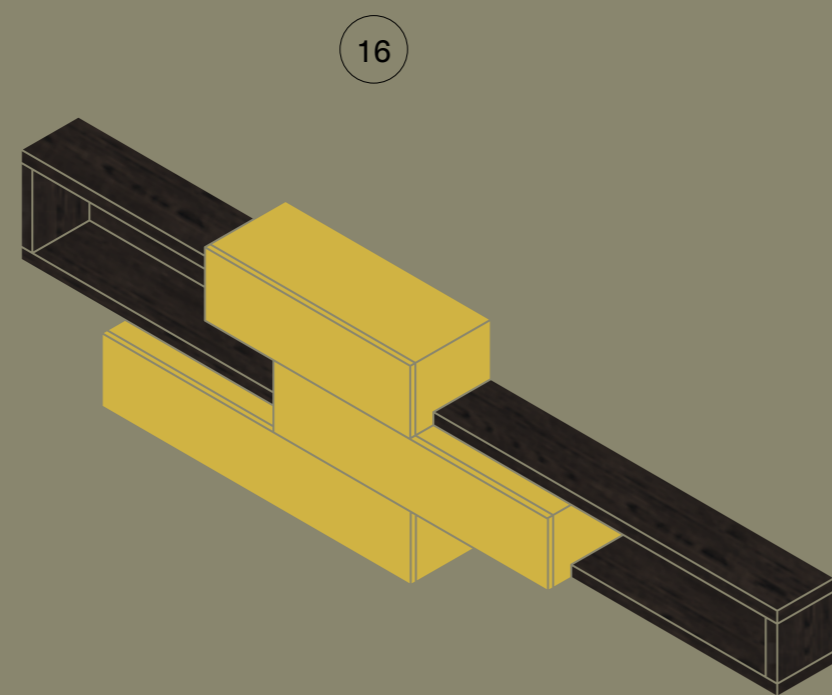
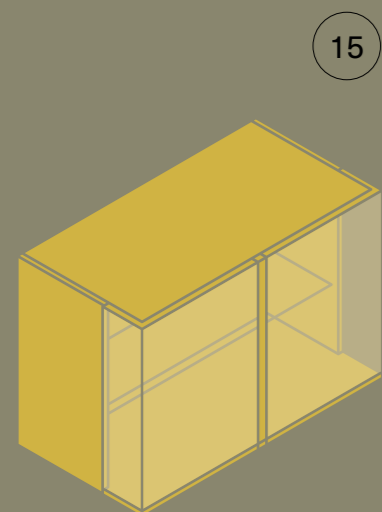
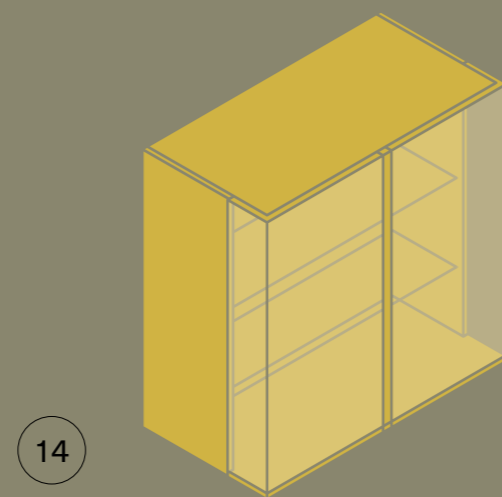
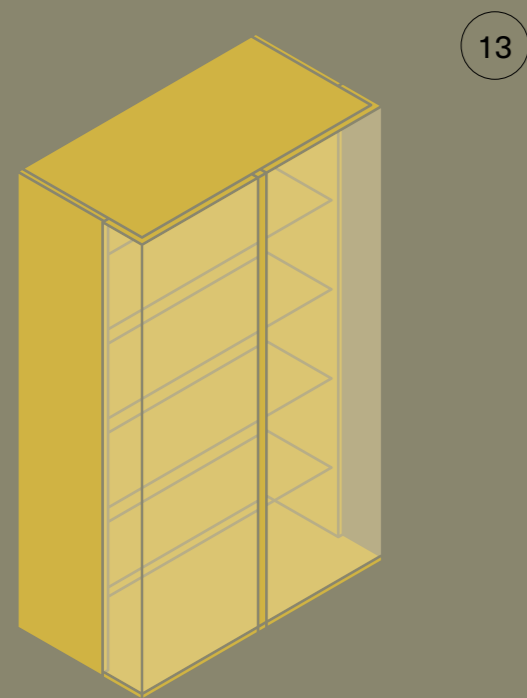

13. Teka

14. Teka

15. Teka

16. Mensole Snake

Day 28

IT – Brillante ed estroverso, il contrasto cromatico di questa composizione è in perfetta sintonia con il suo ardito e informale abbinamento di linee e volumi. Una proposta multifunzionale che integra nella composizione uno scrittoio e una base sospesa con prese per la TV.

EN – Brilliant and extrovert, the colour contrast of this composition is perfectly aligned with its daring and informal combination of lines and volumes. A multifunction product which includes in the composition a desk and a wall-mounted base unit with outlets for the TV.

222 – 223

Finiture / Finishes

Laccato opaco Fulvo, laccato opaco Sabbia. Maniglia Virgo, Push-Pull / Fulvo matte lacquer finish, Sabbia matte lacquer finish. Push-Pull Virgo handle

Elementi / Elements

Basi sospese P 420 mm, libreria sospesa e sovrapposta senza ultimo ripiano P 350 mm / Wall-mounted base units D 420 mm, wall-mounted and superstructure bookcase without top shelf D 350 mm

Dimensioni / Dimensions

L 4230 × H 1676 P 350 – 420 mm







Dettaglio frontale a ribalta su libreria con meccanismo a filo
/Detail of drop-down front on bookcase with flush mechanism



Dettaglio maniglia Virgo su frontali basi sospese
/Detail of Virgo handle on fronts of wall-mounted base units



Dettaglio passacavi su base sospesa per TV
/Detail of cable duct system on wall-mounted base for TV



Day 29

IT – In questa soluzione, il classico assume un significato moderno, armonizzandosi con lo stile di vita e gli spazi di oggi. Prestigiose venature, tonalità che vanno oltre il tempo, preziose trasparenze, compongono un insieme al quale non manca nulla: c'è anche uno scrittoio per i momenti di studio e meditazione.

EN – In this solution the classic takes on a modern meaning, thus blending in with today's lifestyle and spaces. Precious veining, colours that go beyond time, luxury transparencies, make up a whole which lacks nothing: there's also a desk for moments of study and thinking.

Finiture/Finishes

Frassino Cuoio, laccato opaco Artico, vetro Bronzato / Cuoio Ash, Artico matte lacquer finish, Bronzato glass

Elementi/Elements

Libreria a parete con scrittoio Scrigno a ribalta attrezzato internamente di vano a giorno e cassetti in cuoio portaoggetti estraibili, Teka in vetro con ante Glass / Wall bookcase with Scrigno drop-down desk fitted inside with an open unit and leather pull-out drawers for holding objects, Teka in glass with Glass doors

Dimensioni/Dimensions

L 3930 × H 2243 P 350 – 478 mm





Dettaglio scrittoio Scigno a ribalta aperto attrezzato internamente di vano a giorno
/Detail of open Scigno drop-down desk equipped inside with open unit



Dettaglio scrittoio Scigno a ribalta aperto attrezzato internamente di vani a giorno e cassettoni in cuoio Brown estraibili/Detail of open Scigno drop-down desk equipped inside with open units and small pull-out drawers in Brown leather



Dettaglio scrittoio Scigno a ribalta aperto attrezzato internamente di vani a giorno e schiena con specchio
/Detail of open Scigno drop-down desk equipped inside with open units and back with mirror



Dettaglio tavolo Sambuco fisso con piano in marmo Carrara Venatino, sedie Fanny
/Detail of fixed Sambuco table with top in Carrara Venatino, Fanny chairs

Day 30

IT – Un sistema completo per arredare e organizzare lo spazio giorno, trovando sempre una collocazione ideale per il microcosmo di libri, ricordi e oggetti che sono parte integrante della quotidianità. Come uno scrigno domestico, un'anta si schiude su un vano con illuminazione interna, destinato a custodire gelosamente i manufatti più preziosi, sostenendoli su mensole in vetro.

EN – A complete system for furnishing and organising the living area, always finding the ideal place for the small world of books, memories and objects that are an integral part of daily living. Like a domestic treasury, a door opens up on a unit with inside lighting, intended to carefully hold the most precious of objects, supporting them on glass shelves.



Finiture / Finishes

Frassino Ossidato, Frassino Carbone.
Maniglia Piolo, Push-Pull/Ossidato Ash,
Carbone Ash. Push-Pull Piolo handle

Elementi / Elements

Libreria a parete e orizzontale, pensili
per vano spalla, Teke in vetro con anta
Glass / Horizontal wall bookcase,
wall units for side space, Teke in glass
with Glass door

Dimensioni / Dimensions

L 4230 × H 2243 P 350 mm







Dettaglio Teka con ante Glass vetro trasparente, con specchio su schiena, ripiani in cristallo bronzati e illuminazione LED
/Detail of Teka with Glass doors in clear glass, with mirror on back, shelves in bronzati crystal and LED lighting



Day 31

IT – Essere senza apparire, così si potrebbe sintetizzare la filosofia di questa proposta d'arredo, ideale continuazione dell'architettura circostante, con in più un tocco prezioso rappresentato dalle vetrine dotate di illuminazione a LED integrata, con un effetto sia estetico che funzionale.

EN – Substance over appearance could be used to sum up the philosophy behind this range of furniture, an ideal continuation of the surrounding architecture, with an added luxury touch represented by the glass cases fitted with built-in LED lighting with both an aesthetic and functional effect.

Finiture/Finishes

Laccato opaco Piuma, laccato opaco Piombo, vetro trasparente. Maniglia Push-Pull/Piuma matte lacquer finish, Piombo matte lacquer finish, clear glass. Push-Pull handle

Elementi/Elements

Libreria a parete P 350 mm, Teke in vetro con ante Glass, basi sospese P 420 mm /Wall bookcase D 350 mm, Teke in glass with Glass doors, wall-mounted base units D 420 mm

Dimensioni/Dimensions

L 4530 x H 2243 P 350 – 420 mm





Dettaglio Teka in vetro con ante Glass attrezzata internamente di ripiano in cristallo Bronzati, schiena Rombo laccata opaca Piombo e illuminazione LED /Detail of Teka in glass with Glass doors fitted inside with a shelf in Bronzati crystal, Rombo back, Piombo matte lacquer finish and LED lighting



Dettaglio base sospesa con frontale a ribalta e meccanismo a filo /Detail of wall-mounted base unit with drop-down front and flush mechanism

Illuminazione
/ Lighting
pagina 254

Finiture e colori
/ Finishes and colours
pagina 258 › 259

Tecnologia
/ Technology
pagina 255

Maniglie
/ Handles
pagina 256

Aperture
/ Openings
pagina 257

Dati tecnici / Technical data

Illuminazione / Lighting



LED orizzontale su ripiano spalla / Horizontal LED on side shelf



LED verticale su bussolotto / Vertical LED on swivel support



LED su ripiano in vetro / LED on glass shelf

Tecnologia / Technology



Passacavi / Cable duct



Ricarica USB / USB charger



Ricarica wireless / Wireless charger

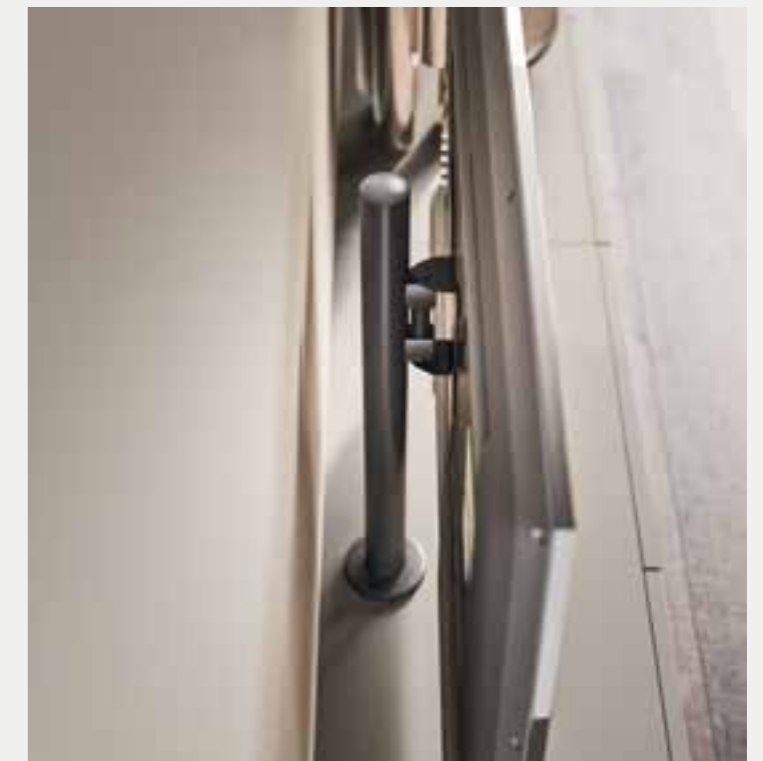

Palo TV / TV post

Maniglie / Handles



Lateral



Linea



Virgo



Tratto



Piolo



Push-Pull

Aperture / Openings

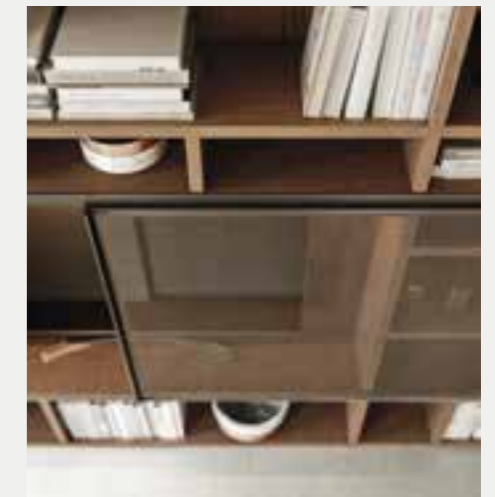
Meccanismo a filo
/ Flush mechanismMeccanismo a pistone
/ Piston mechanismCerniera ante battenti
/ Hinge for side-hinged doorsInterno cassetto/cassettone
/ Standard/large drawer interiorCerniera anta vetro glass
/ Hinge for Glass doorAnta scorrevole spalla
/ Side sliding doorAnta scorrevole Casellario Air
/ Sliding door for Air open shelf

Materico finitura legno / Textured wood finishes

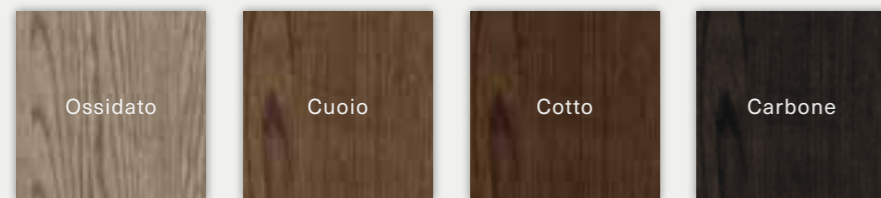

Materico colore opaco / Textured matte colour finishes

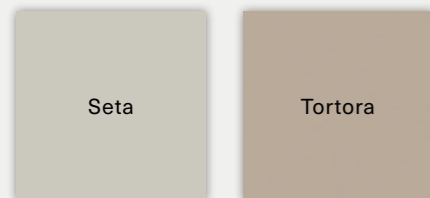

Impiallacciati / Veneers

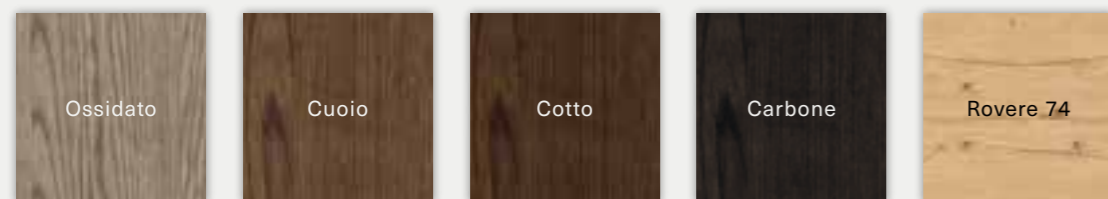

Cemento / Concrete

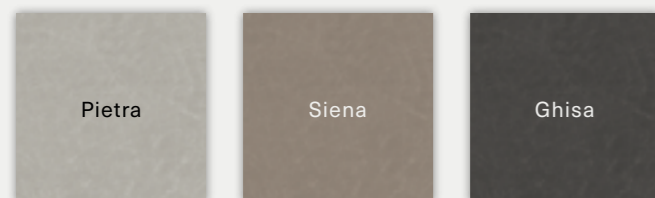

Vetri (sp. 4 mm) / Glass panes (thickness 4 mm)

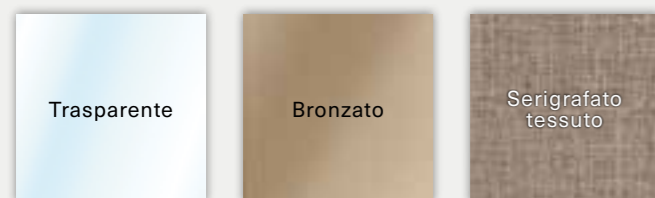

Specchi (sp. 4 mm) / Mirrors (thickness 4 mm)

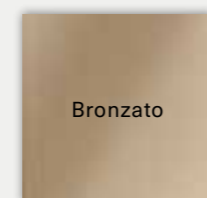

Laccati opachi e lucidi / Matte and gloss lacquer finishes



Rombo laccato opaco / Matte lacquer finish Rombo

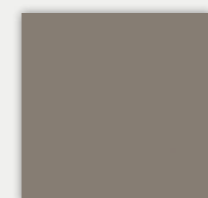

Laminat (sp. 8 mm)

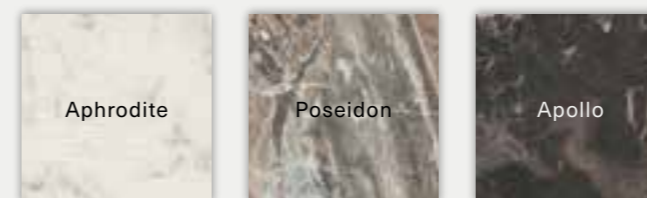



AZIENDE DEL GRUPPO HOMES

SAN MICHELE
ORME
CLEVER
MISTRAL
NARDIINTERNI

ORME

Homes CASA Srl
Via Montello, 80
31053 – Pieve di Soligo
(TV) Italia

Servizio clienti Italia
t. +39 0438 984 581
f. +39 0438 984 589
e. orme@homes.it
w. ormedesign.it

Export Department
t. +39 0438 839 832
f. +39 0438 839 859
e. export@homes.it
w. homes.it

Homes S.p.a. – Headquarters
Via Montello, 63/1
31053 – Pieve di Soligo
(TV) Italia
t. +39 0438 9909 081
f. +39 0438 909 089
e. info@homes.it
w. homes.it

Homes Casa s.r.l. si riserva di apportare in qualsiasi momento modifiche a prodotti, misure e materiali, che riterrà utile per esigenze di carattere produttivo e commerciale. Per essere sempre aggiornati vi invitiamo a consultare il nostro sito internet www.ormedesign.it. Le tonalità di colore e le finiture illustrate vanno considerate puramente indicative. Verificarne sempre la fattibilità dell'abbinamento finiture consultando il listino.



L1X00300



